



Product  
*Brochure*  
Cold Room-Storage



Cold Room /  
Storage



Industrial  
Refrigeration

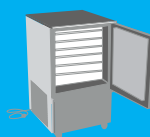

Commercial  
Refrigeration

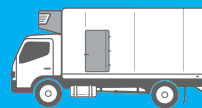

Transport  
Refrigeration



Ammonia  
Refrigeration



Incepted in the year 1980, Bharat Refrigerations Pvt Ltd has strived its utmost to provide solution to the cooling needs and requirements of our valued customers. Designed in compliance with verified industry standard, our products are widely acknowledged for maximum cooling efficiency, low power consumption and longer service life. Bharat Refrigerations Pvt Ltd has been taken over by Ice Make Refrigeration Limited in December 2016, to serve its Valued Customers by providing total cooling solution & better after-sales services in southern part of India.

Bharat Refrigerations is committed to help you to meet the demands of foods safety, energy efficiency and reliable performance. We ensure these to you through our competitive pricing, professional advice and innovative design.

### About Us



Customer Focus



Honour Commitments



Embrace Innovation



Responsive Service



Building Trust



Believe in Solution



Transparency



Listen to Your Needs



# The Core of **TRUST** **SATISFACTION**

Your **Trusted Cooling Partner**  
for the preserve ahead

We have earned trusted business relationship with our customers by consistent performance through quality, delivery and after-sales service.

## Why Bharat Refrigerations?

We are in the business of exploring new frontiers with innovative ideas in providing complete cooling solutions for total customer satisfaction.

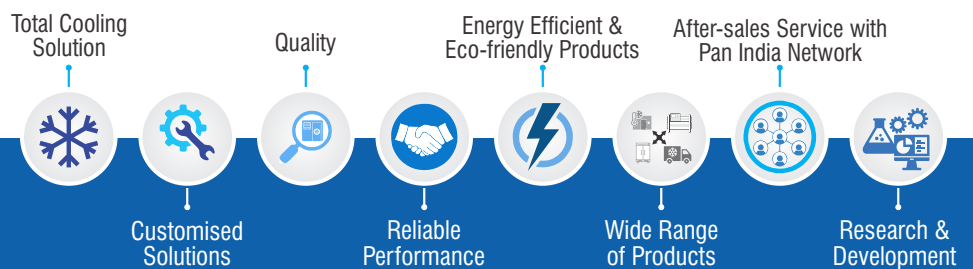

## Contents

Cold Room	01
Sliding Door	07
Solar Cold Room	09
Glass Door Display Chiller	11
Refrigeration System	13
Evaporator Manual	17
Ripening Chamber	21
Other Business Verticals	23
Our Valued Clients	23
Network	24
Project Details	24

Bharat Refrigerations is a leading manufacturer and supplier of highly efficient Cold Room and Storage that is easy to operate and better in performance. This tailor-made product range is built with premium quality range of material in standard size and customised specification to fulfil our customer needs. These Cold Rooms are well insulated, highly efficient and precisely designed to cater to a wide temperature range from +15°C to -40°C.



## Applications: Industries such as



Fruits & Vegetables



Pharmaceutical & Chemical



Ice Cream



Dry Fruits & Spices



Meat & Fish



Bakery Products



Frozen Food



Floriculture

## Total Cold Chain Solution





## Technical Specification

- Thickness** : 60, 80, 100, 125 & 150 mm
- Surface Material** : GI Pre-Painted Sheet, S.S. Sheet (Grade 304/316 & Surface finish 2B & Mate), GI Plain Sheet, Plain Galvanized Iron. (Inside & Outside different metal can be placed as per your requirement)
- Floor** : (A) For Kota stone or Concrete floor, PUF Slab with both side tar felt coated.  
 (B) For Kota Stone or Concrete floor, PUF Panel with Metal Surface at Both Side. Where Panel fits together with camlock to prevent heat loss.  
 (C) Aluminium Chequered Plate with Marine Ply.  
 (D) FRP Cladding on floor
- Door** : (A) Flush Type Swing Door with FRP Profile, Imported Hardware, Push Type Gasket & replaceable heater for easy door operation & long life  
**Opening Size:** 24"x72", 30"x72", 34"x78", 46"x84" (Door Opening W x H)  
 (B) Overlap Type Swing door with frame and metal covering by using heavy duty hardware for better strength  
**Opening Size:** 46"x84", 49"x84", 54"x84", 60"x90" (Door Opening W x H)
- Room Size** : (A) Length & Width Minimum 1.78 mtr and Bigger size 0.146 mtr in multiples as per requirement  
 (B) Standard Height :  
 60 mm - 2.47 mtr, 80 mm - 2.51 mtr,  
 100 mm - 2.55 mtr, 125 mm - 2.60 mtr,  
 150 mm - 2.65 mtr, Single Panel Height upto 12 mt and above as per your requirement.

## Accessories

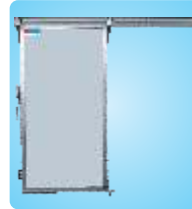

**Sliding Door:-**  
 Opening Size  
**Width** : 1000/1200/1500/1800 mm  
**Height** : 2100 to 3000 mm  
**Thickness** : 80 mm  
**Panel Surface Material** : Both side GIPP or S.S as per requirement



**Hatch Window:-**  
 Opening Size (WxH): 20"x20", 24"x24", 30"x30"  
 Different size hatch window with sturdy frame for easy material movement in high turnover ice cream and dairy industries.



**Pressure Ventilator:-**  
 Tri-action pressure ventilator with/without heater to balance pressure and vacuum inside cold room.

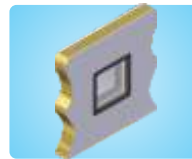

**View Port:-**  
 12"x12" View port with three layer argon filled, toughen glass which can be visible up to 2°C inside the cold room.



**Strip Curtain:-**  
 Semi transparent PVC strip curtain for negative temperature application to prevent heat loss and ultimately the power.



Wall Guard



Door Accessories



LED Vapour proof bulk head



High-Low Temperature Alarm



Inside Safety Alarm



Door with Kick Plate



Ramp with Chequered Plate

## 3D / Plan View of Ice Cream Cold Room

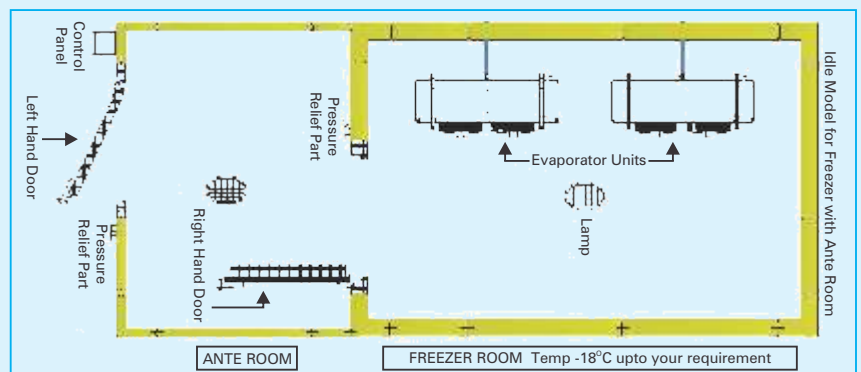

Note : For Positive temperature Ante Room is not Compulsory

## Panel Construction Configuration

### Types of Cold Room Floor

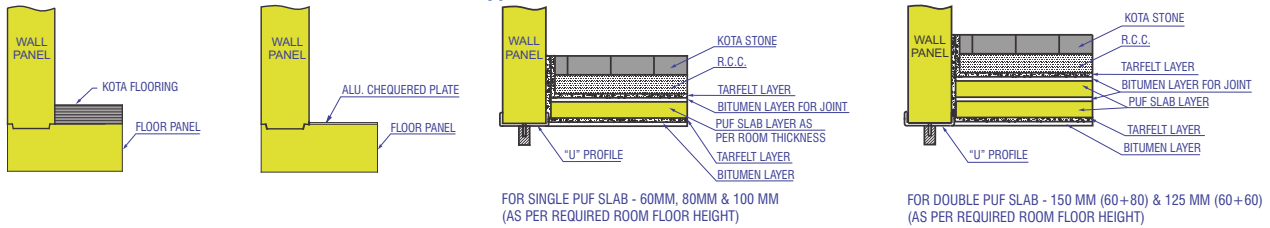

### Vertical & Top Panel Joining Method

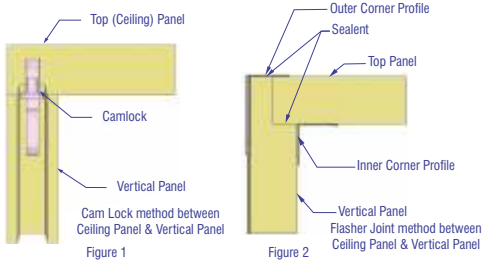

### Corner-Vertical Panel Joining Method

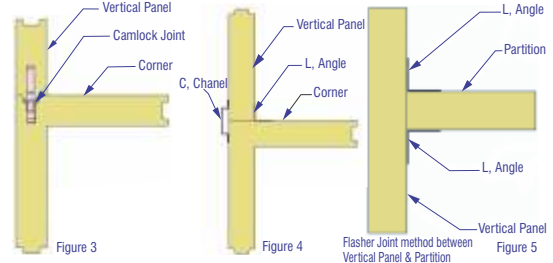

### Door on Floor Panel Design

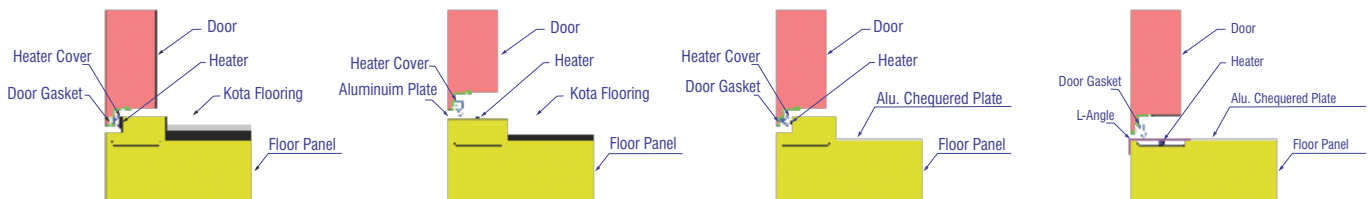

### "C" & Z Channel Door Design

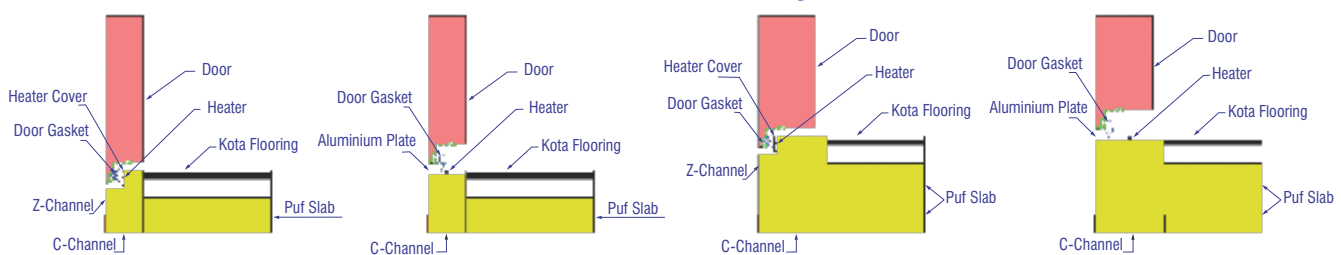

### Ceiling Panel Hanging Method

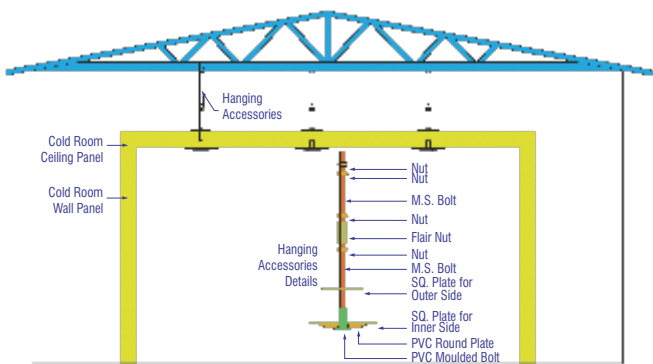

### Panel Width Size

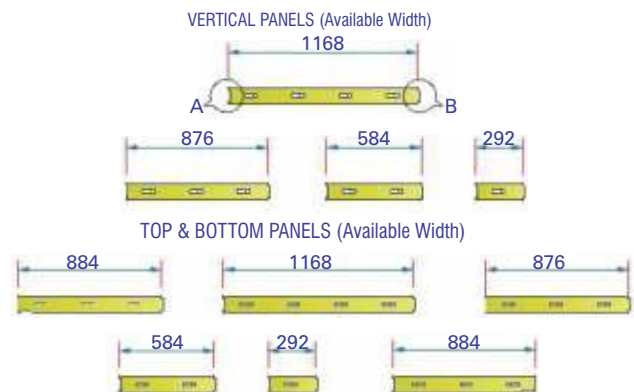

### Corners

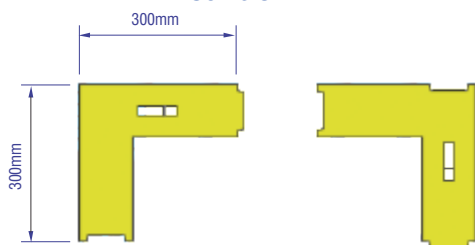

### Panel Joints



## Available Cold Room Size

### Standard Length & Width (with common thickness)

Inch	Feet	Meter	Inch	Feet	Meter	Inch	Feet	Meter	Inch	Feet	Meter	Inch	Feet	Meter
41.25"	3' - 5.25"	1.05	282.75"	23' - 6.75"	7.18	524.25"	43' - 8.25"	13.32	765.75"	63' - 9.75"	19.45	1007.25"	83' - 11.25"	25.58
47"	3' - 11"	1.19	288.5"	24' - 0.5"	7.33	530"	44' - 2"	13.46	771.5"	64' - 3.5"	19.6	1013"	84' - 5"	25.73
52.75"	4' - 4.75"	1.34	294.25"	24' - 6.25"	7.47	535.75"	44' - 7.75"	13.61	777.25"	64' - 9.25"	19.74	1018.75"	84' - 10.75"	25.88
58.5"	4' - 10.5"	1.49	300"	25'	7.62	541.5"	45' - 1.5"	13.75	783"	65' - 3"	19.89	1024.5"	85' - 4.5"	26.02
64.25"	5' - 4.25"	1.63	305.75"	25' - 5.75"	7.77	547.25"	45' - 7.25"	13.9	788.75"	65' - 8.75"	20.03	1030.25"	85' - 10.25"	26.17
70"	5' - 10"	1.78	311.5"	25' - 11.5"	7.91	553"	46' - 1"	14.05	794.5"	66' - 2.5"	20.18	1036"	86' - 4"	26.31
75.75"	6' - 3.75"	1.92	317.25"	26' - 5.25"	8.06	558.75"	46' - 6.75"	14.19	800.25"	66' - 8.25"	20.33	1041.75"	86' - 9.75"	26.46
81.5"	6' - 9.5"	2.07	323"	26' - 11"	8.2	564.5"	47' - 0.5"	14.34	806"	67' - 2"	20.47	1047.5"	87' - 3.5"	26.61
87.25"	7' - 3.25"	2.22	328.75"	27' - 4.75"	8.35	570.25"	47' - 6.25"	14.48	811.75"	67' - 7.75"	20.62	1053.25"	87' - 9.25"	26.75
93"	7' - 9"	2.36	334.5"	27' - 10.5"	8.5	576"	48'	14.63	817.5"	68' - 1.5"	20.76	1059"	88' - 3"	26.9
98.75"	8' - 2.75"	2.51	340.25"	28' - 4.25"	8.64	581.75"	48' - 5.75"	14.78	823.25"	68' - 7.25"	20.91	1064.75"	88' - 8.75"	27.04
104.5"	8' - 8.5"	2.65	346"	28' - 10"	8.79	587.5"	48' - 11.5"	14.92	829"	69' - 1"	21.06	1070.5"	89' - 2.5"	27.19
110.25"	9' - 2.25"	2.8	351.75"	29' - 3.75"	8.93	593.25"	49' - 5.25"	15.07	834.75"	69' - 6.75"	21.2	1076.25"	89' - 8.25"	27.34
116"	9' - 8"	2.95	357.5"	29' - 9.5"	9.08	599"	49' - 11"	15.21	840.5"	70' - 0.5"	21.35	1082"	90' - 2"	27.48
121.75"	10' - 1.75"	3.09	363.25"	30' - 3.25"	9.23	604.75"	50' - 4.75"	15.36	846.25"	70' - 6.25"	21.49	1087.75"	90' - 7.75"	27.63
127.5"	10' - 7.5"	3.24	369"	30' - 9"	9.37	610.5"	50' - 10.5"	15.51	852"	71'	21.64	1093.5"	91' - 1.5"	27.77
133.25"	11' - 1.25"	3.38	374.75"	31' - 2.75"	9.52	616.25"	51' - 4.25"	15.65	857.75"	71' - 5.75"	21.79	1099.25"	91' - 7.25"	27.92
139"	11' - 7"	3.53	380.5"	31' - 8.5"	9.66	622"	51' - 10"	15.8	863.5"	71' - 11.5"	21.93	1105"	92' - 1"	28.07
144.75"	12' - 0.75"	3.68	386.25"	32' - 2.25"	9.81	627.75"	52' - 3.75"	15.94	869.25"	72' - 5.25"	22.08	1110.75"	92' - 6.75"	28.21
150.5"	12' - 6.5"	3.82	392"	32' - 8"	9.96	633.5"	52' - 9.5"	16.09	875"	72' - 11"	22.22	1116.5"	93' - 0.5"	28.36
156.25"	13' - 0.25"	3.97	397.75"	33' - 1.75"	10.1	639.25"	53' - 3.25"	16.24	880.75"	73' - 4.75"	22.37	1122.25"	93' - 6.25"	28.51
162"	13' - 6"	4.11	403.5"	33' - 7.5"	10.25	645"	53' - 9"	16.38	886.5"	73' - 10.5"	22.52	1128"	94'	28.65
167.75"	13' - 11.75"	4.26	409.25"	34' - 1.25"	10.39	650.75"	54' - 2.75"	16.53	892.25"	74' - 4.25"	22.66	1133.75"	94' - 5.75"	28.8
173.5"	14' - 5.5"	4.41	415"	34' - 7"	10.54	656.5"	54' - 8.5"	16.68	898"	74' - 10"	22.81	1139.5"	94' - 11.5"	28.94
179.25"	14' - 11.25"	4.55	420.75"	35' - 0.75"	10.69	662.25"	55' - 2.25"	16.82	903.75"	75' - 3.75"	22.96	1145.25"	95' - 5.25"	29.09
185"	15' - 5"	4.7	426.5"	35' - 6.5"	10.83	668"	55' - 8"	16.97	909.5"	75' - 9.5"	23.1	1151"	95' - 11"	29.24
190.75"	15' - 10.75"	4.85	432.25"	36' - 0.25"	10.98	673.75"	56' - 1.75"	17.11	915.25"	76' - 3.25"	23.25	1156.75"	96' - 4.75"	29.38
196.5"	16' - 4.5"	4.99	438"	36' - 6"	11.13	679.5"	56' - 7.5"	17.26	921"	76' - 9"	23.39	1162.5"	96' - 10.5"	29.53
202.25"	16' - 10.25"	5.14	443.75"	36' - 11.75"	11.27	685.25"	57' - 1.25"	17.41	926.75"	77' - 2.75"	23.54	1168.25"	97' - 4.25"	29.67
208"	17' - 4"	5.28	449.5"	37' - 5.5"	11.42	691"	57' - 7"	17.55	932.5"	77' - 8.5"	23.69	1174"	97' - 10"	29.82
213.75"	17' - 9.75"	5.43	455.25"	37' - 11.25"	11.56	696.75"	58' - 0.75"	17.7	938.25"	78' - 2.25"	23.83	1179.75"	98' - 3.75"	29.97
219.5"	18' - 3.5"	5.58	461"	38' - 5"	11.71	702.5"	58' - 6.5"	17.84	944"	78' - 8"	23.98	1185.5"	98' - 9.5"	30.11
225.25"	18' - 9.25"	5.72	466.75"	38' - 10.75"	11.86	708.25"	59' - 0.25"	17.99	949.75"	79' - 1.75"	24.12	1191.25"	99' - 3.25"	30.26
231"	19' - 3"	5.87	472.5"	39' - 4.5"	12	714"	59' - 6"	18.14	955.5"	79' - 7.5"	24.27	1197"	99' - 9"	30.4
236.75"	19' - 8.75"	6.01	478.25"	39' - 10.25"	12.15	719.75"	59' - 11.75"	18.28	961.25"	80' - 1.25"	24.42	1202.75"	100' - 2.75"	30.54
242.5"	20' - 2.5"	6.16	484"	40' - 4"	12.29	725.5"	60' - 5.5"	18.43	967"	80' - 7"	24.56	1208.50"	100' - 8.5"	30.69
248.25"	20' - 8.25"	6.31	489.75"	40' - 9.75"	12.44	731.25"	60' - 11.25"	18.57	972.75"	81' - 0.75"	24.71	1214.25"	101' - 2.25"	30.84
254"	21' - 2"	6.45	495.5"	41' - 3.5"	12.59	737"	61' - 5"	18.72	978.5"	81' - 6.5"	24.85	1220"	101' - 8.0"	30.98
259.75"	21' - 7.75"	6.6	501.25"	41' - 9.25"	12.73	742.75"	61' - 10.75"	18.87	984.25"	82' - 0.25"	25	1225.75"	102' - 1.75"	31.13
265.5"	22' - 1.5"	6.74	507"	42' - 3"	12.88	748.5"	62' - 4.5"	19.01	990"	82' - 6"	25.15	1231.5"	102' - 7.5"	31.28
271.25"	22' - 7.25"	6.89	512.75"	42' - 8.75"	13.02	754.25"	62' - 10.25"	19.16	995.75"	82' - 11.75"	25.29	1237.25"	103' - 1.25"	31.42
277"	23' - 1"	7.04	518.5"	43' - 2.5"	13.17	760"	63' - 4"	19.3	1001.5"	83' - 5.5"	25.44	1243"	103' - 7"	31.57

### Standard Height (with common thickness)

Height	Thickness	60 mm					
		PUF Slab			Alu. Checkered		
		Wall Panel	Inch	Feet	Meter	Inch	Feet
St. Height-1	92.5	94.9	7'-10.9"	2.4101	97.22	8'-1.2"	2.47
St. Height-2	112	114.4	9'-6.4"	2.91	116.7	9'-8.7"	2.96
Maximum single panel	472.5	242.2	20'-2.4"	6.1576	244.7	20'-4.7"	6.22

Height	Thickness	80 mm					
		PUF Slab			Alu. Checkered		
		Wall Panel	Inch	Feet	Meter	Inch	Feet
St. Height-1	92.5	95.6	7'-11.6"	2.43	98.8	8'-2.8"	2.51
St. Height-2	112	115.1	9'-7.1"	2.92	118.3	9'-10.3"	3
Maximum single panel	472.5	243.1	20'-3.1"	6.18	246.3	20'-6.3"	6.26

Height	Thickness	100 mm					
		PUF Slab			Alu. Checkered		
		Wall Panel	Inch	Feet	Meter	Inch	Feet
St. Height-1	92.5	96.4	8'-0.4"	2.45	100.39	8'-4.4"	2.55
St. Height-2	112	115.9	9'-7.9"	2.94	119.9	9'-11.9"	3.05
Maximum single panel	472.5	243.9	20'-3.9"	6.20	247.9	20'-7.9"	6.30

Height	Thickness	125 mm					
		PUF Slab			Alu. Checkered		
		Wall Panel	Inch	Feet	Meter	Inch	Feet
St. Height-1	92.5	97.4	8'-1.4"	2.48	102.34	8'-6.3"	2.60
St. Height-2	112	116.9	9'-8.9"	2.97	121.8	10'-1.8"	3.09
Maximum single panel	472.5	244.9	20'-4.9"	6.22	249.8	20'-9.8"	6.35

Height	Thickness	150 mm					
		PUF Slab			Alu. Checkered		
		Wall Panel	Inch	Feet	Meter	Inch	Feet
St. Height-1	92.5	98.4	8'-2.4"	2.50	104.3	8'-8.3"	2.65
St. Height-2	112	117.9	9'-9.9"	2.99	123.8	10'-3.8"	3.14
Maximum single panel	472.5	245.9	20'-5.9"	6.25	251.8	20'-11.8"	6.40

PUF Thickness (mm)	Recomm -ended Temp. Degree @ 32°C Ambient Temp.	Weight						Thermal Conductivity 'K' Value W/mK	Thermal Transmittance 'U' Value W/m²K	Thermal Resistance 'R' Value m²K/W	Thermal Transmittance 'U' Value K.Cal/m²K	Thermal Resistance 'R' Value m²K/K.Cal
		Wall & Ceiling		Floor Panel		Alu. Checkered Floor <small>NOTE for Alu. Checkered floor: The above is actual panel weight with one side GPP 0.45 mm thk. &amp; other side 9 mm marine ply with 2 mm Al. checkered plate and it includes accessories!</small>						
		Floor bare slab		Floor Panel								
		Kg/Sq.ft	Kg/Sq.mtr	Kg/Sq.ft	Kg/Sq.mtr							
60	+20 to +2	0.9	9.67	0.25	3	2.5	27	0.022	0.3521	2.84	0.3018	3.31
80	+2 to -8	1	10.82	0.35	4	2.6	28	0.022	0.2679	3.73	0.2296	4.36
100	-8 to -18	1.06	11.3	0.425	5	2.7	29	0.022	0.2163	4.62	0.1854	5.39
125	-18 to -27	1.2	12.72	0.525	6	2.85	31	0.022	0.1721	5.81	0.1475	6.78
150	-27 to -50	1.25	13.45	0.65	7	3	32	0.022	0.1459	6.85	0.1251	7.99

Thermal Flux (Heat loss per m² wall area) at different ΔT													
Panel Thickness (mm)	Temp. Difference °C	W/m²						K.cal / m²					
		60	80	100	125	150	60	80	100	125	150		
		60	80	100	125	150	60	80	100	125	150		
1		0.3521	0.2679	0.2163	0.1721	0.1459	0.3018	0.2296	0.1854	0.1475	0.1251		
10		3.5205	2.6797	2.1631	1.7556	1.4596	3.0174	2.2968	1.8540	1.5047	1.2510		
15		5.2808	4.0196	3.2446	2.6335	2.1894	4.5262	3.4452	2.7810	2.2572	1.8766		
20		7.0411	5.3595	4.3262	3.5113	2.9192	6.0349	4.5936	3.7080	3.0095	2.5021		
25		8.8014	6.6993	5.4077	4.3891	3.6491	7.5437	5.7419	4.6350	3.7619	3.1276		
30		10.5617	8.0391	6.4893	5.2670	4.3789	9.0524	6.8903	5.5620	4.5143	3.7531		
35		12.3219	9.3790	7.5708	6.1447	5.1087	10.5611	8.0387	6.4890	5.2667	4.3786		
40		14.0822	10.7189	8.6524	7.0226	5.8384	12.0699	9.1871	7.4159	6.0191	5.0041		
45		15.8424	12.0587	9.7340	7.9004	6.5682	13.5786	10.3356	8.3430	6.7714	5.6296		
50		17.6028	13.3986	10.8155	8.7782	7.2980	15.0873	11.4840	9.2699	7.5238	6.2551		
55		19.3631	14.7385	11.8971	9.6561	8.0278	16.5961	12.6324	10.1970	8.2762	6.8806		
60		21.1239	16.0784	12.9786	10.5339	8.7576	18.1053	13.7808	11.1239	9.0286	7.5062		
65		22.8836	17.4182	14.0602	11.4117	9.4874	19.6135	14.9292	12.0510	9.7810	8.1317		
70		24.6439	18.4382	15.1417	12.2896	10.2172	21.1223	15.8034	12.9779	10.5334	8.7572		
80		28.1644	21.4377	17.3048	14.0452	11.6769	24.1397	18.3743	14.8320	12.0382	10.0082		

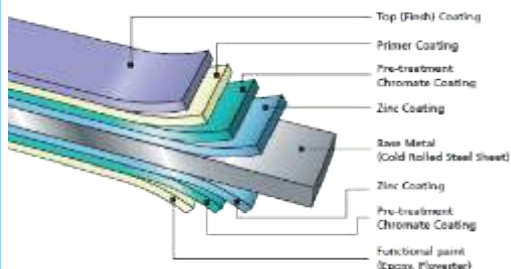

## Technical Specifications of PUF Panels

Sr.No.	PARAMETERS	DESCRIPTION
1	Average PUF Density	40 ± 2 kg/m <sup>3</sup>
2	PUF Blowing Agent	141B (CFC free)
3	Insulation Material	Polyurethane foam
4	Temperature range	+90°C to -60°C
5	Panel Type	Discontinuous type with camlock
6	M.O.C. of Camlocks	Cam locks body material HIPS and male latch is made of nylon Glass field with GI sheet reinforcement. Cam-lock panel joints easy assembly and leakage resistant, panel-to-panel joints.
7	Type of Panel joints	Tongue & Groove Joint with Cam lock and all side rubber gaskets
8	Corner Panel Available	12" x 12" x 162" (maximum Length)
9	Length of Wall & ceiling Panel	2032 mm to 12000 mm      80" to 472.5" inch
10	Ceiling Suspension items with specs	MS bolt with thermal breaking cap. PVC Round Plate 6 mm thickness x 90 mm diameter Aluminium/MS washer plate for load distribution Anchor bolt (MS) hanging bolt with 40 mm washer 2.0 mm thickness Sealing to panel MS road Clamp with an insulated crown.
11	Closed cell content	90 to 95%
12	Vapour Permeability	5.5mg/PASM
13	Water Absorption	Less than 2%
14	Fire Grade Polyurethane PUF Panel	FR Grade B3 (Fire Retardant Grade)
15	Compressive Strength at 10% Deformation	0.21 N/ sq.mm (For PUF only)
16	Tensile Strength	0.58 N /sq.mm (For PUF only)
17	Adhesive Strength (Foam to Sheet)	2.9 kg /sq.mtr
18	Dimension Stability	Less than 2%
19	Panel Facing Availability	With Rib or plain on Demand (Ribs are provided for more strength)
20	Wall & Ceiling Panel facing Material	<ul style="list-style-type: none"> <li>• Pre Painted Galvanised sheet , Thickness 0.45mm</li> <li>• Plain Galvanised sheet , Thickness 0.45mm</li> <li>• S.S. Sheet, Grade 316, 0.50mm, finish 2B/0.6 mm mate No.4</li> <li>• S.S. Sheet, Grade 304, 0.50mm, finish 2B/0.6 mm mate No.4</li> </ul>
21	Floor Panel Facing Material	<ul style="list-style-type: none"> <li>• PUF Panel with both side tarfelt sheet.</li> <li>• PUF Panel with both side 0.45mm GIPP sheet.</li> <li>• PUF Panel with outside GIPP sheet, inside 9 mm thick marine ply with 2 mm thick Aluminium Chequered Plate</li> </ul>
22	Specification for Colour Coating	 <p> <b>A.</b> RAL No. : 9002 or it's nearest  <b>B.</b> Indian Standard code              Colour Coating : IS 14246 Galvanizing : IS 277 Base Metal : IS 513  <b>C.</b> Organic Coating : Type RMP (Polyester)  <b>D.</b> Zinc Coating : 120 GSM  <b>E.</b> Top Primer (Thickness in micron 'μ') : 5 +/- 1 μ  <b>F.</b> Top Coat (Thickness in micron 'μ') : 20 +/- 1 μ  <b>G.</b> Back Primer (Thickness in micron 'μ') : 4 +/- 1 μ  <b>H.</b> Back Coat (Thickness in micron 'μ') : 4 +/- 1 μ  <b>I.</b> Guard Film (Thickness in micron 'μ') : 40 +/- 3 μ  <b>J.</b> Salt Spray Test /Humidity Test : 750 hrs. /1000 hrs.         </p>

**Bharat Refrigerations** Sliding Doors are delivered as complete units, easy to mount with all fittings, sliding rail and bottom guide roller etc. Sliding Doors are designed for tough commercial environments such as Cold Stores, Incubation Chamber and Blast Chiller.

These Sliding Doors are very easy to operate, greater in efficiency and better in performance; also in terms of safety, long service life and smooth in everyday operation with one hand.

Bharat Refrigerations Sliding Door has sealed upper surface to resist dirt build up, very easy to clean and very easy to operate.

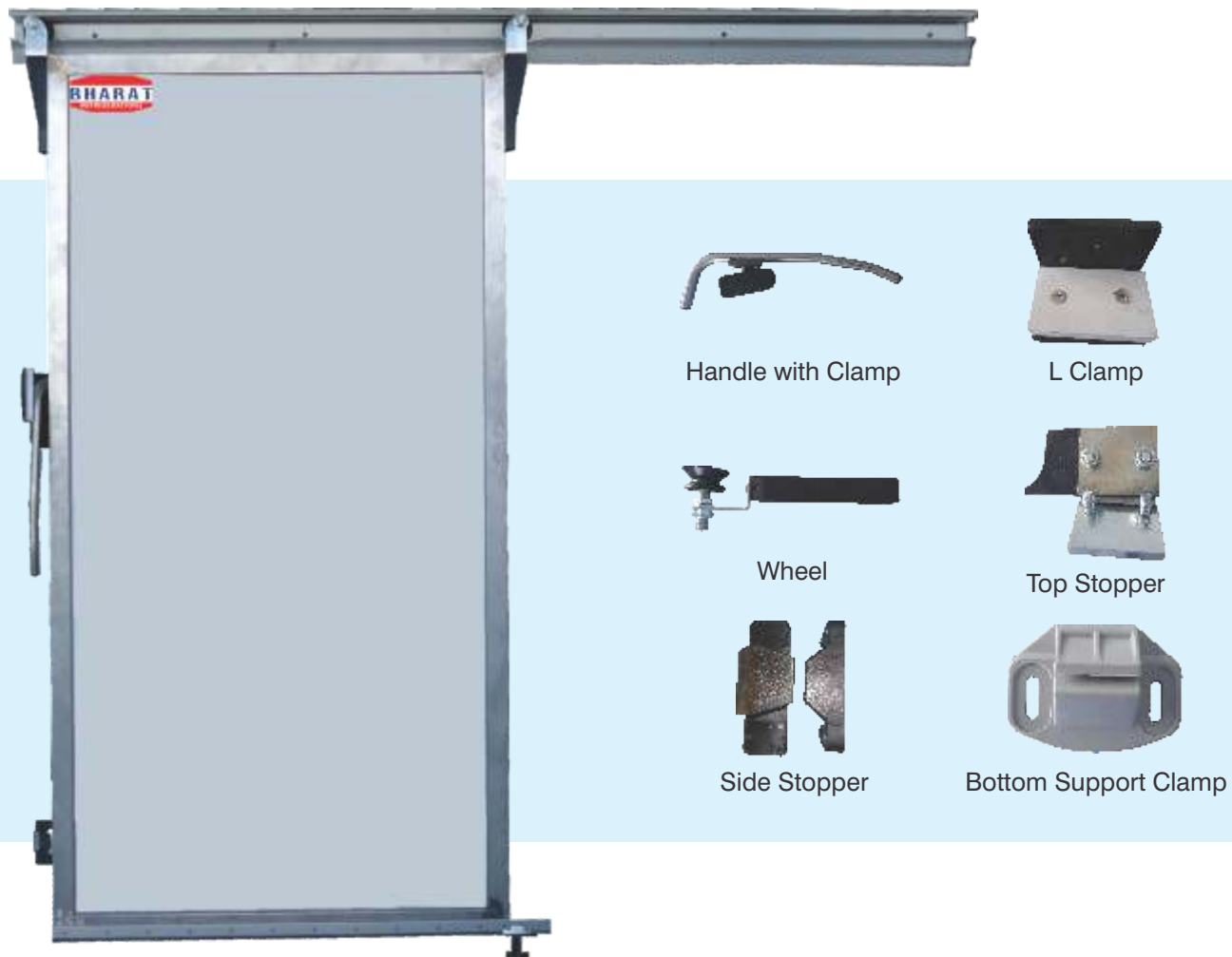

### **Bharat Refrigerations Sliding Door Features:**

- Heavy duty imported hardware
- Formed in place door panels
- S.S door frame
- Heavy duty track and wheel for durability
- Door guide to keep door on track
- Gasket to seal off air leak
- Durable and long service life, corrosion and Wear-resistant
- Easy maintenance & robust in design
- Outstanding ease of operation by manual
- High standard of hygiene and easy-to-clean surfaces

## Technical Specifications

<b>Door Panel</b>	80 mm thick (rigid Polyurethane foam)
<b>Door Frames</b>	Assembled in Panel
<b>Surface Finish</b>	The surface finish is available in a range of RAL No. 9002 or its nearest colours, with Pre-painted sheet, S.S sheet (304/316), GI Plain Sheet, Galvanium with thickness of 0.45 mm.
<b>Insulation</b>	Injected Polyurethane insulation with, <ul style="list-style-type: none"> <li>• Thermal Conductivity 0.022 W/m<sup>2</sup>K</li> <li>• Density 40 ± 2 kg/m<sup>3</sup></li> <li>• Tensile Strength 0.58 N/mm<sup>2</sup></li> <li>• Vapour permeability 5.5 mg/PASM</li> </ul>
<b>Hardware</b>	<ul style="list-style-type: none"> <li>• Anodized Aluminium Upper Guide rail</li> <li>• Availability of floor (F) guide Clamp</li> <li>• Brackets in reinforced composite material and zinc-coated metal</li> <li>• Outside opening devices with lever handle</li> <li>• Mounting on pre-fabricated panel</li> <li>• Simple and quick cleaning surface</li> <li>• Indoor Leaf with Replaceable Single Gasket</li> </ul>

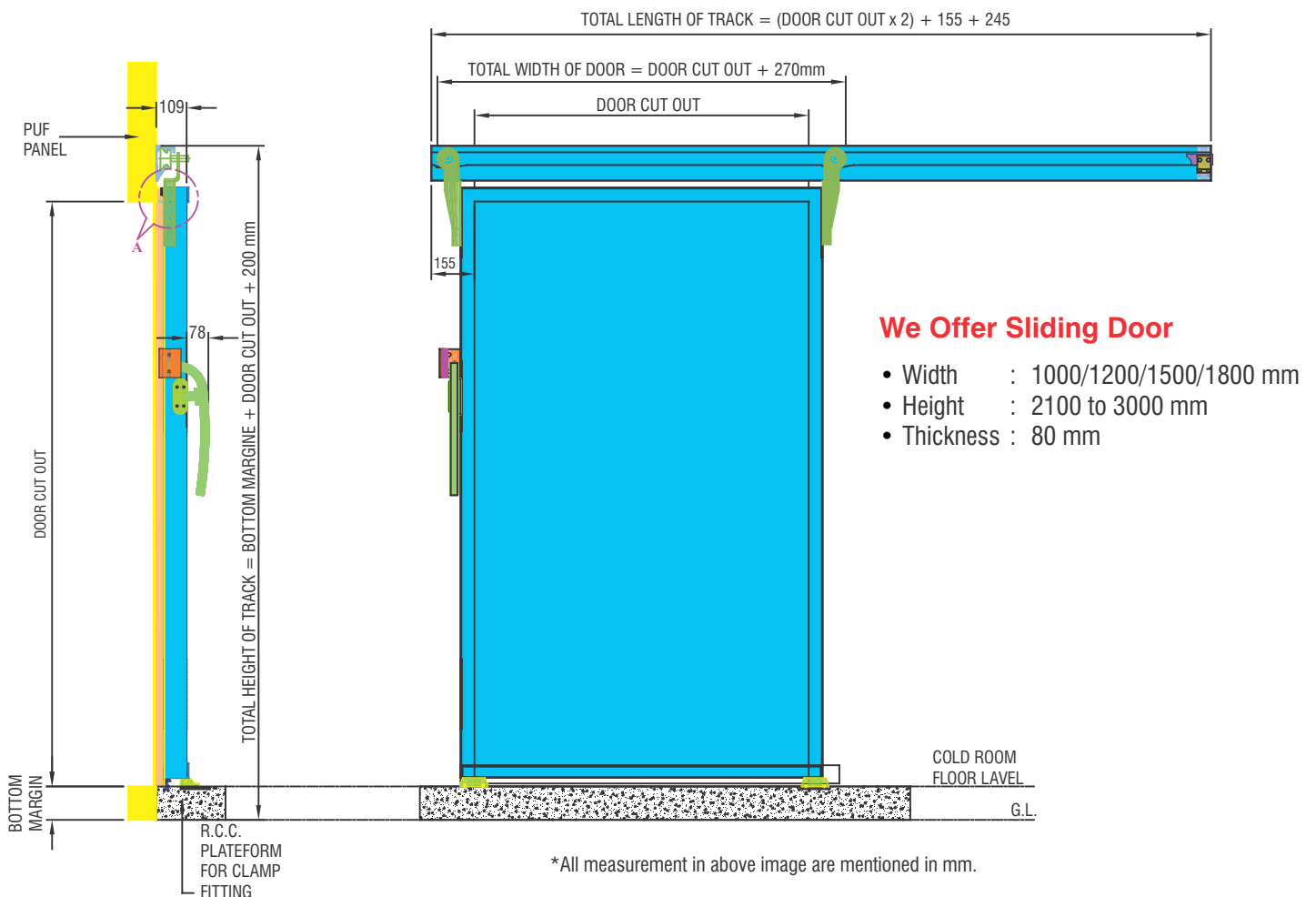



24 Hours Backup  
(No Door Opening)



Low  
Maintenance



Solar Powered  
Stand-alone

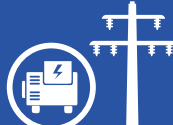

Grid &  
DG Set Hybrid



No Battery for  
Refrigeration



No Running Cost  
on Solar Supply



Portable / Easy  
to Shift



Bharat Refrigerations has gained continuous appreciation as the prime organization offering Commercial & Industrial Refrigeration Equipment catering to Industries like Dairy, Ice Cream, Food Processing, Fruit Ripening, Horticulture/Floriculture, Hotels-Restaurants, Pharmaceuticals, Logistics, Plastic and Chemical Industry etc. This appreciation encouraged us to develop the innovative Cold Storage powered by solar stand-alone for improving storage quality and reducing wastage of horticulture and floriculture produce.

Most of the Horticulture/Floriculture produce requires a cooling temperature between 0°C to 15°C for safe storage and transient purposes. In the absence of cold storage and related cold chain facilities, the farmers are forced to sell their produce immediately after harvest which results in over abundance and low price realization.

Stand-alone Solar Power is one of the best solutions for operating small cold storage system in rural areas where there is certain limit of power load. Solar energy based refrigeration system is quite relevant to Indian weather because it is blessed with a good amount of solar energy in most parts of the country, throughout the year. This rich source of endless solar energy is the main power source for the Solar Cold Room built by Bharat Refrigerations and it gives a 24 Hours backup with no door opening.

Bharat Refrigerations Solar Cold Room is a Hybrid Cold Room designed to use throughout the year, even when there is no sunlight. This Solar Cold Room can be used with the alternate power source during the absence of Sunlight i.e. Electric Power and/or DG Power.

The Plug & Play feature of this Solar Cold Room makes it portable. Being portable, this Cold Room can be shifted anytime anywhere as per your convenience with no installation cost. Additionally the maintenance is very low and there is no running cost while operating through solar stand-alone. These characteristics make this Solar Cold Room best suited & affordable for farmers.



## Specification

Cold room size(LxWxH)	: 20'10" x 7'9" x 7'11"
Polyurethane Insulation Thickness	: 100 mm
Product capacity	: 4 to 5 MT
Loading rate	: 10 %
Backup	: ■ 24 hour with no loading and no door opening condition : ■ 16 hour with 10% loading and 10times door opening condition
Temperature range	: 2°C to 20°C
Product	: Fruits-Vegetables, Flower, Pharma and Dairy Items
Solar Panel	: 5 kW



Other capacities also available, contact us for more details.

## 24 Hours Temperature Graph

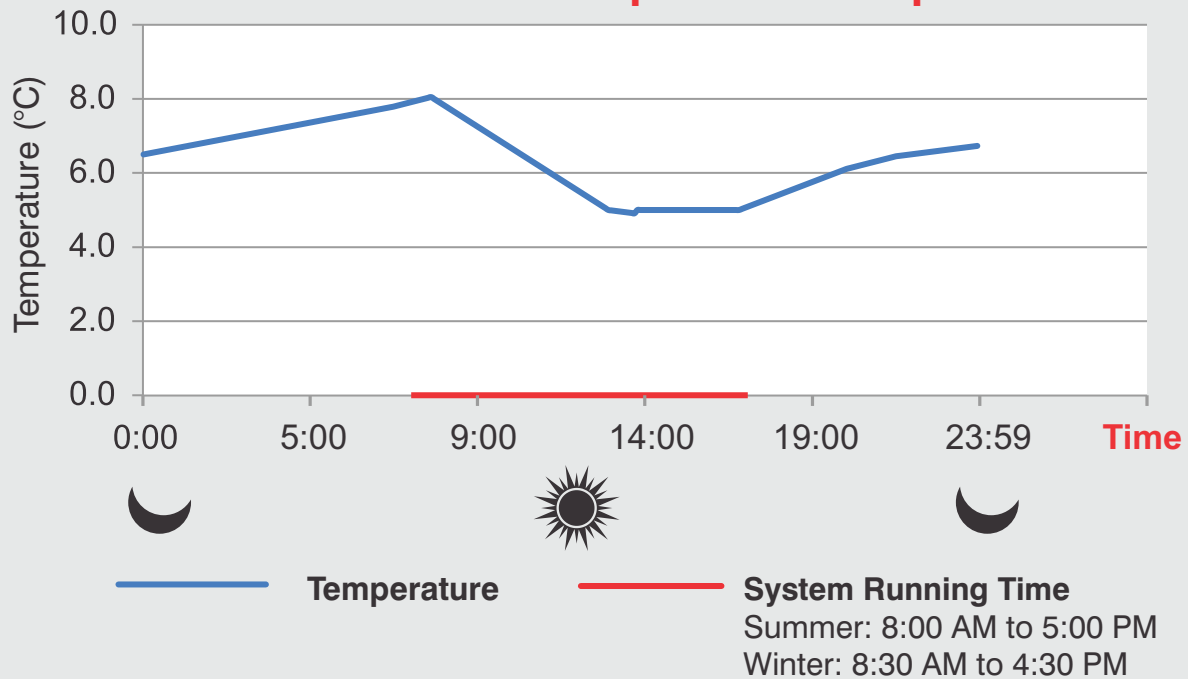

Fruit



Flower



Vegetable



Dairy



Pharma

Bharat Refrigerations Glass Door Display Chillers are suitable for super markets and retail shops to preserve and display Dairy items, Cake-pastry, Chocolates, Beverages, Fruits & Vegetables, Flower, Medicines etc. These glass door display chillers are designed and developed with utmost eminence in accordance with the defined parameters of the industry and emerging market demands this classic design combined with up-to-date technology enable timeless and functional display solutions that enable high-quality product presentation. These display chillers are divided into two sections to keep a variety of items as display and storage inside.

**Temperature : 2°C to 8°C**



## Special Features

- Large Storage with Better Display Area
- Uniform Temperature
- Energy efficient
- Customized size
- Easy maintenance
- Easy to assemble & dismantle

## Available Glass Door Display Chiller Size:

Display Area				Display with Storage Area			
No. of Door	Chiller Size (L x W x H)	Volume (CFT)	Connected Power	No. of Door	Chiller Size (L x W x H)	Volume (CFT)	Connected Power
2	65.23" x 47" x 98.8"	126	1 / 3 Ph, 1.58 kW	2	65.23" x 93" x 98.8"	269	1 / 3 Ph, 1.68 kW
3	93.22" x 47" x 98.8"	201	1 / 3 Ph, 1.68 kW	3	93.22" x 93" x 98.8"	429	1 / 3 Ph, 1.68 kW
4	127.5" x 47" x 98.8"	264	1 / 3 Ph, 1.68 kW	4	127.5" x 93" x 98.8"	563	1 / 3 Ph, 2.17 kW
5	156.25" x 58.5" x 98.8"	419	1 / 3 Ph, 2.17 kW	5	156.25" x 93" x 98.8"	696	3 Ph, 3.26 kW
6	185" x 58.5" x 98.8"	499	1 / 3 Ph, 2.17 kW	6	185" x 93" x 98.8"	829	3 Ph, 3.26 kW

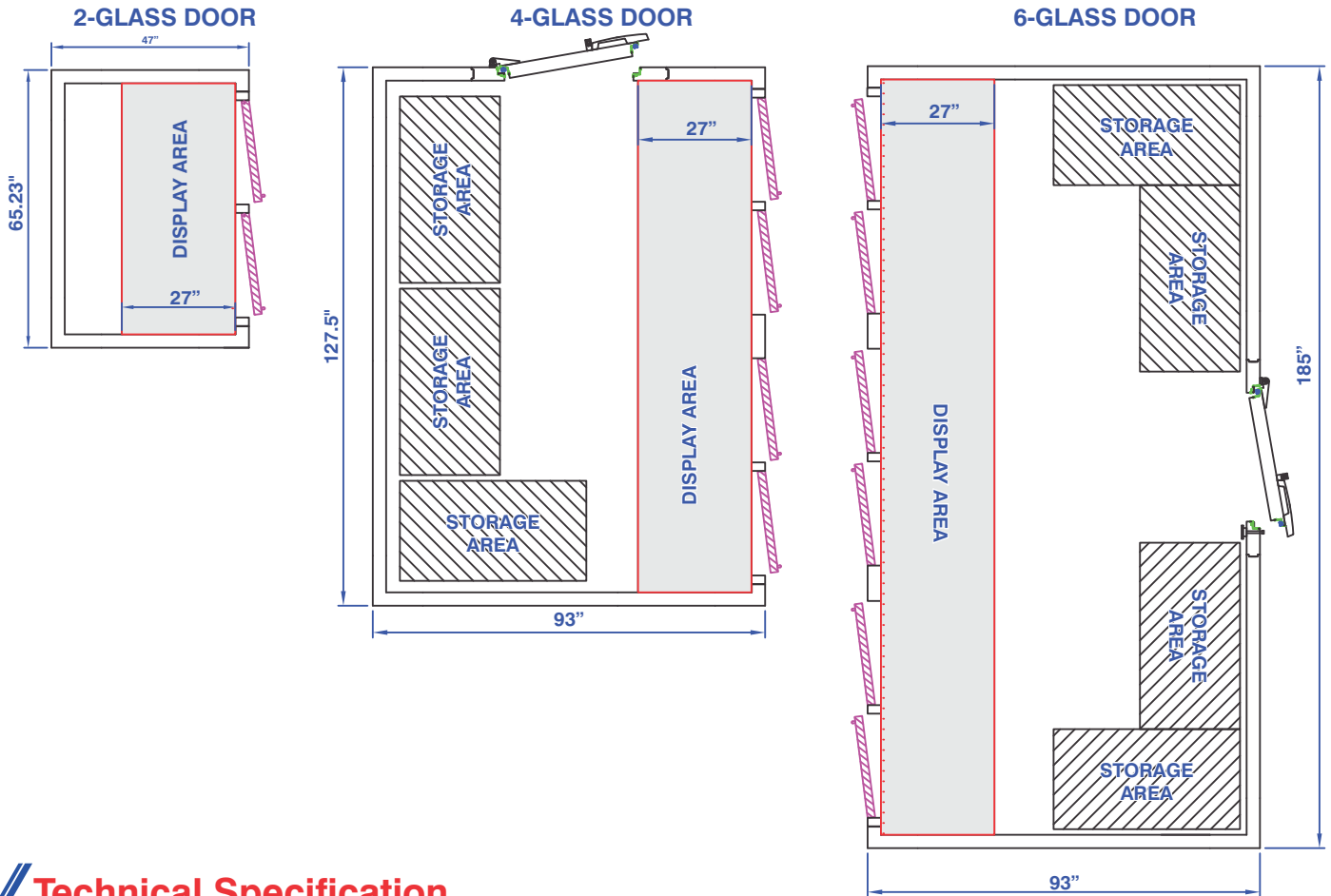

## Technical Specification

- **Glass Door Frame Size :** 1401 mm x 1840 mm, **Single Door Opening Size :** 600 mm x 1720 mm.
- Customized glass doors (hinged type) with magnetic door gasket for air tight seal.
- Minimum 2 Glass Door.
- Floor Insulation: Aluminium Chequered plate.
- Digital temperature controller with digital display.
- Insulated perimeter frames designed with forward facing for easy service and maintenance from front of the door.
- Energy efficient frame that reduces heat loss by 30% with its added insulation
- Double layer vacuumed tempered glass to prevent moisture.
- For specific arrangement of products.
- Adjustable Stainless Steel Shelves for specific arrangements of merchandise.
- Provision for special demands such as glass doors, special flooring, silent condensing unit, Shelves etc.
- Long durability and perfect construction with balanced refrigeration system.





## Condensing Unit

Air-cooled & Water-cooled

Slim Type

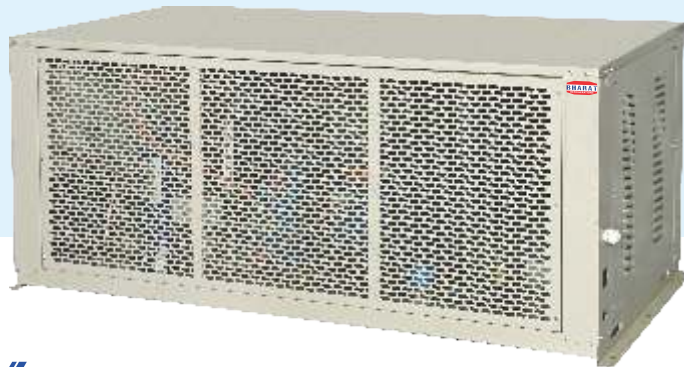

Screw Type Condensing Unit

## Features

- High cooling with low power consumption
- Designed for high ambient condition up to 55°C
- Condensing coil with inner grooved copper tubes & aluminum fins
- Efficient fans with external motors for single phase and three phase
- High & low pressure cut-out including mounting brackets, wired to terminal strip
- Large size filter drier, moisture indicator, solenoid valve, oil separator and accumulator
- Shell & tube type condenser with high cooling capacity for high ambient conditions

## Rack System - An Advanced Refrigeration Technology :

- It has advanced power saving system compared to normal refrigeration system
- Rack system will work as per product load variation



Water-Cooled



Water-Cooled



Air-Cooled



## Evaporator Unit



### FEATURES

- **Fan** - High reliability, low-temperature resistance and low noise external rotor fans.
- **Coil** - High efficiency heat exchange with in-line tube system for minimum loss of air flow between fans and large surface area for better cooling.
- **Defrost** - Electrically heating stainless steel pipe is used for long life and it is also leak proof.
- **Unit Body** - Aluminium, PU type Powder Coated, Corrosion resistant and nice appearance body.
- **Maintenance** - Compact, adjustable & easily openable side panels for easy installation.

## Control Panel



### Features

- Temperature Controls
- Phase Preventing
- HP-LP
- Over current protection
- Auto Defrost
- Delay timer

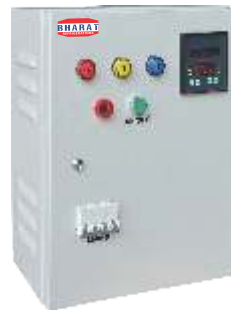

### Features

- Phase Preventing
- HP/LP
- Over/Under current protection
- High-Low temperature alarm
- Quick freezing option
- Door alarm
- All type of trip alarm & Record date
- Available in Air & Water cooled system

## Dehumidifier

Bharat Refrigerations portable dehumidifier provides low humidity conditions necessary to maintain a dry environment. It's a simple solution to an old problem. This Dehumidifier works by forcing condensation on cold surfaces. Humid air is drawn over cooled fins that makes moisture condense on the large cool surface. The condensation is allowed to drain from the fins into a collection tank or is piped to a suitable drainage. Cooled dry air passes through condenser coil and again heated to desired temperature to maintain low relative humidity.

### Application

- Sweet storage
- Dehydrated product storage
- Seeds storage
- Bakery product storage and many more

### Features

- Auto cut-off according to set RH value
- Automatic defrost
- Top air flow
- Continuous drainage option or water collecting tank



Particular	Model - 1	Model - 2	Model - 3	Model - 4
Moisture condense capacity (@ 20°C & 60% RH) (L/day)	16	37	60	112
Refrigerant	R-134a	R-22	R-22	R-22
Air flow (m <sup>3</sup> /h)	130	300	600	1000
Connected power (kW)	0.6	1.25	1.5	3
Max power (kW)	0.9	1.6	1.8	3.5
Power supply	1ph, 220V	1ph, 220V	1ph, 220V	1ph, 220V

## Model Code Logic

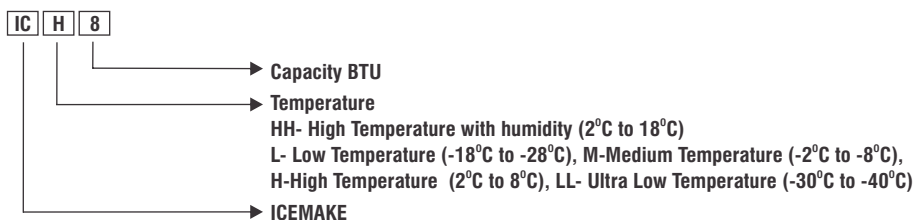

## REFRIGERATION TECHNICAL DATA

Sr. No	Model	Cold Room Volume		Suggested Cooling Capacity					Connected Load kW	Power Supply	Condensor		Refrigerant		Compressor Type		
		CFT	CMT	Watts	H.P.	Cal.	BTU	TR			Air Cooled	Water Cooled	R-404	R-22	Reци procating	Scroll	Semi Sealed
<b>FOR HIGH TEMPERATURE @ 2°C TO 8°C</b>																	
1	ICH-8	300	8	2198	2.95	1890	7500	0.62	1.8	1ph	Yes	No	No	Yes	Yes	No	No
2	ICH-12	500	14	3443	4.62	2961	11748	0.98	2.6/1.93	1/3ph	Yes	Optional	Yes	Yes	Yes	No	Yes
3	ICH-17	650	18	4899	6.57	4213	16715	1.39	3.1/2.63	1/3ph	Yes	Optional	Yes	Yes	Yes	Yes	Yes
4	ICH-20	900	25	5634	7.55	4845	19223	1.60	3.08	3ph	Yes	Optional	Yes	Yes	Yes	Yes	Yes
5	ICH-23	1100	31	7630	10.23	6562	26034	2.17	4.03	3ph	Yes	Optional	Yes	Yes	Yes	Yes	Yes
6	ICH-40	1900	54	12146	16.28	10446	41442	3.45	6.11	3ph	Yes	Optional	Yes	Yes	Yes	Yes	Yes
7	ICH-53	2400	68	15776	21.15	13567	53828	4.48	7.9	3ph	Yes	Optional	Yes	Yes	Yes	Yes	Yes
8	ICH-71	3200	91	20357	27.29	17507	69458	5.78	10.14	3ph	Yes	Optional	Yes	Yes	Yes	Yes	Yes
9	ICH-85	4000	113	25420	34.08	21861	86733	7.22	12.51	3ph	Yes	Optional	Yes	Yes	Yes	Yes	Yes
10	ICH-100	5200	147	29886	40.06	25702	101971	8.49	14.89	3ph	Yes	Optional	Yes	Yes	No	Yes	Yes
11	ICH-145	7000	198	42391	56.82	36456	144638	12.04	21.91	3ph	Yes	Optional	Yes	Yes	No	Yes	Yes
12	ICH-175	9000	255	51390	68.89	44195	175343	14.60	25.61	3ph	Yes	Optional	Yes	Yes	No	Yes	Yes
13	ICH-210	11000	311	62586	83.90	53824	213543	17.78	32.86	3ph	Yes	Optional	Yes	Yes	No	Yes	Yes
<b>FOR MEDIUM TEMPERATURE @ -2°C TO -8°C</b>																	
14	ICM-4	250	7	1250	1.68	1075	4265	0.36	1.31	1ph	Yes	No	No	Yes	Yes	No	No
15	ICM-9	450	13	2751	3.69	2366	9386	0.78	2.4/1.8	1/3ph	Yes	Optional	Yes	Yes	Yes	No	Yes
16	ICM-12	600	17	3813	5.11	3279	13010	1.08	2.8/2.51	1/3ph	Yes	Optional	Yes	Yes	Yes	Yes	Yes
17	ICM-15	800	23	4620	6.19	3973	15763	1.31	3	3ph	Yes	Optional	Yes	Yes	Yes	Yes	Yes
18	ICM-17	1000	28	4778	6.40	4109	16303	1.36	3.92	3ph	Yes	Optional	Yes	Yes	Yes	Yes	Yes
19	ICM-28	1700	48	7875	10.56	6773	26870	2.24	4.88	3ph	Yes	Optional	Yes	Yes	Yes	Yes	Yes
20	ICM-40	2200	62	11722	15.71	10081	39995	3.33	7.48	3ph	Yes	Optional	Yes	Yes	Yes	Yes	Yes
21	ICM-53	2900	82	15739	21.10	13536	53701	4.47	9.79	3ph	Yes	Optional	Yes	Yes	Yes	Yes	Yes
22	ICM-65	3750	106	20153	27.01	17332	68762	5.73	11.83	3ph	Yes	Optional	Yes	Yes	Yes	Yes	Yes
23	ICM-80	4700	133	23950	32.10	20597	81717	6.80	14.24	3ph	Yes	Optional	Yes	Yes	No	Yes	Yes
24	ICM-112	6400	181	33530	44.95	28836	114404	9.53	21.16	3ph	Yes	Optional	Yes	Yes	No	Yes	Yes
25	ICM-135	8100	229	39750	53.28	34185	135627	11.29	24.55	3ph	Yes	Optional	Yes	Yes	No	Yes	Yes
26	ICM-210	9000	255	46600	62.47	40076	158999	13.24	31.68	3ph	Yes	Optional	Yes	Yes	No	Yes	Yes

Sr. No	Model	Cold Room Volume		Suggested Cooling Capacity					Connected Load kW	Power Supply	Condensor		Refrigerant		Compressor Type		
		CFT	CMT	Watts	H.P.	Cal.	BTU	TR			Air Cooled	Water Cooled	R-404	R-22	Reci procating	Scroll	Semi Sealed
<b>FOR LOW TEMPERATURE @ -18°C TO -28°C</b>																	
27	ICL-3	300	8	550	0.74	473	1877	0.16	2.5	1ph	Yes	No	Yes	No	Yes	No	No
28	ICL-4	350	10	1145	1.53	985	3907	0.33	1.98	3ph	Yes	No	Yes	No	Yes	Yes	No
29	ICL-6	550	16	1788	2.40	1538	6101	0.51	3	3ph	Yes	Yes	Yes	No	Yes	Yes	Yes
30	ICL-9	850	24	2743	3.68	2359	9359	0.78	4.1	3ph	Yes	Yes	Yes	No	Yes	Yes	Yes
31	ICL-13	1200	34	3328	4.46	2862	11355	0.95	5.4	3ph	Yes	Yes	Yes	No	Yes	Yes	Yes
32	ICL-18	1700	48	4743	6.36	4079	16183	1.35	6.9	3ph	Yes	Yes	Yes	No	Yes	Yes	Yes
33	ICL-26	2500	71	7960	10.67	6846	27160	2.26	8.6	3ph	Yes	Yes	Yes	No	Yes	Yes	Yes
34	ICL-38	3400	96	11355	15.22	9765	38743	3.23	10.6	3ph	Yes	Yes	Yes	No	No	Yes	Yes
35	ICL-42	3800	107	10870	14.57	9348	37088	3.09	11.5	3ph	Yes	Yes	Yes	No	No	Yes	Yes
36	ICL-45	4000	113	12745	17.08	10961	43486	3.62	13.5	3ph	Yes	Yes	Yes	No	No	No	Yes
37	ICL-50	5000	141	15390	20.63	13235	52511	4.37	15.18	3ph	Yes	Yes	Yes	No	No	No	Yes
38	ICL-65	6500	184	18690	25.05	16073	63770	5.31	20.29	3ph	Yes	Yes	Yes	No	No	No	Yes
30	ICL-80	8000	226	21875	29.32	18813	74638	6.21	23.65	3ph	Yes	Yes	Yes	No	No	No	Yes
40	ICL-105	10500	297	27810	37.28	23917	94888	7.90	32.4	3ph	Yes	Yes	Yes	No	No	No	Yes
<b>FOR HIGH TEMPERATURE @ 2°C TO 18°C WITH HUMIDITY FOR RIPENING / PRE-COOLING</b>																	
41	ICHH-12	1200	34	5107	6.85	4392	17425	1.45	2.03	1/3ph	Yes	No	Yes	Yes	Yes	Yes	Yes
42	ICHH-17	1500	42	5033	6.75	4328	17173	1.43	2.53	3ph	Yes	Yes	Yes	Yes	Yes	Yes	Yes
43	ICHH-20	1700	48	8125	10.89	6988	27723	2.31	3.27	3ph	Yes	Yes	Yes	Yes	Yes	Yes	Yes
44	ICHH-23	2200	62	10930	14.65	9400	37293	3.11	4.02	3ph	Yes	Yes	Yes	Yes	Yes	Yes	Yes
45	ICHH-40	3500	99	17648	23.66	15177	60215	5.01	6.15	3ph	Yes	Yes	Yes	Yes	Yes	Yes	Yes
46	ICHH-53	4500	127	22869	30.66	19667	78029	6.50	8.13	3ph	Yes	Yes	Yes	Yes	Yes	Yes	Yes
47	ICHH-71	7000	198	29769	39.90	25601	101572	8.46	10.45	3ph	Yes	Yes	Yes	Yes	Yes	Yes	Yes
48	ICHH-85	8000	226	38056	51.01	32728	129847	10.81	12.97	3ph	Yes	Yes	Yes	Yes	Yes	Yes	Yes
<b>FOR ULTRA LOW TEMPERATURE -30°C TO -40°C</b>																	
49	ICLL-17	as per heat load		5100	6.84	4386	17401	1.45	5.82	3ph	Yes	Yes	Yes	No	semi-sealed two stage		Yes
50	ICLL-24			7673	10.29	6599	26180	2.18	7.63	3ph	Yes	Yes	Yes	No			Yes
51	ICLL-39			12025	16.12	10342	41029	3.42	12.26	3ph	Yes	Yes	Yes	No			Yes
52	ICLL-55			16185	21.70	13919	55223	4.60	15.57	3ph	Yes	Yes	Yes	No			Yes
53	ICLL-64			19215	25.76	16525	65562	5.46	18.43	3ph	Yes	Yes	Yes	No			Yes
54	ICLL-72			22315	29.91	19191	76139	6.34	21.05	3ph	Yes	Yes	Yes	No			Yes
55	ICLL-86			27135	36.37	23336	92585	7.71	25.5	3ph	Yes	Yes	Yes	No			Yes

\* Connected load & Cooling Capacity will differ as per compressor



**A4007-301H, A7012-301A**

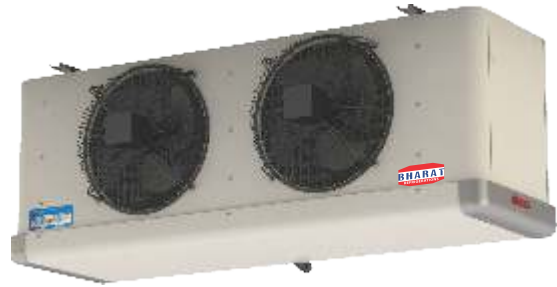

**A4012-302H, A7021-302A**



**A4018-303H, A7032-303A**



**A4024-353H, A4034-353H  
A7043-353A, A7060-353A**



**A4039-452H, A7062-452A**



**A4058-453H, A7090-453A**



**CLS709-252A**



**CLD713-252A, CLD719-252A**



**CLD724-253A, CLD729-253A**



## Model Code Logic

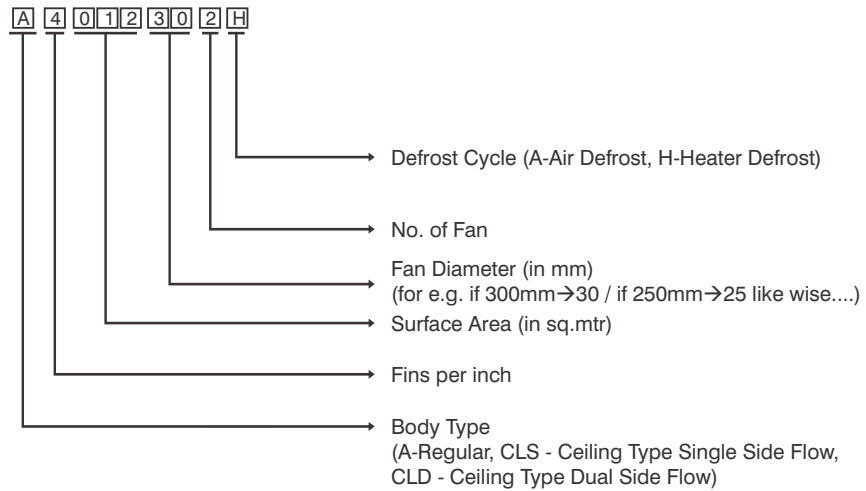

## Physical Dimensions

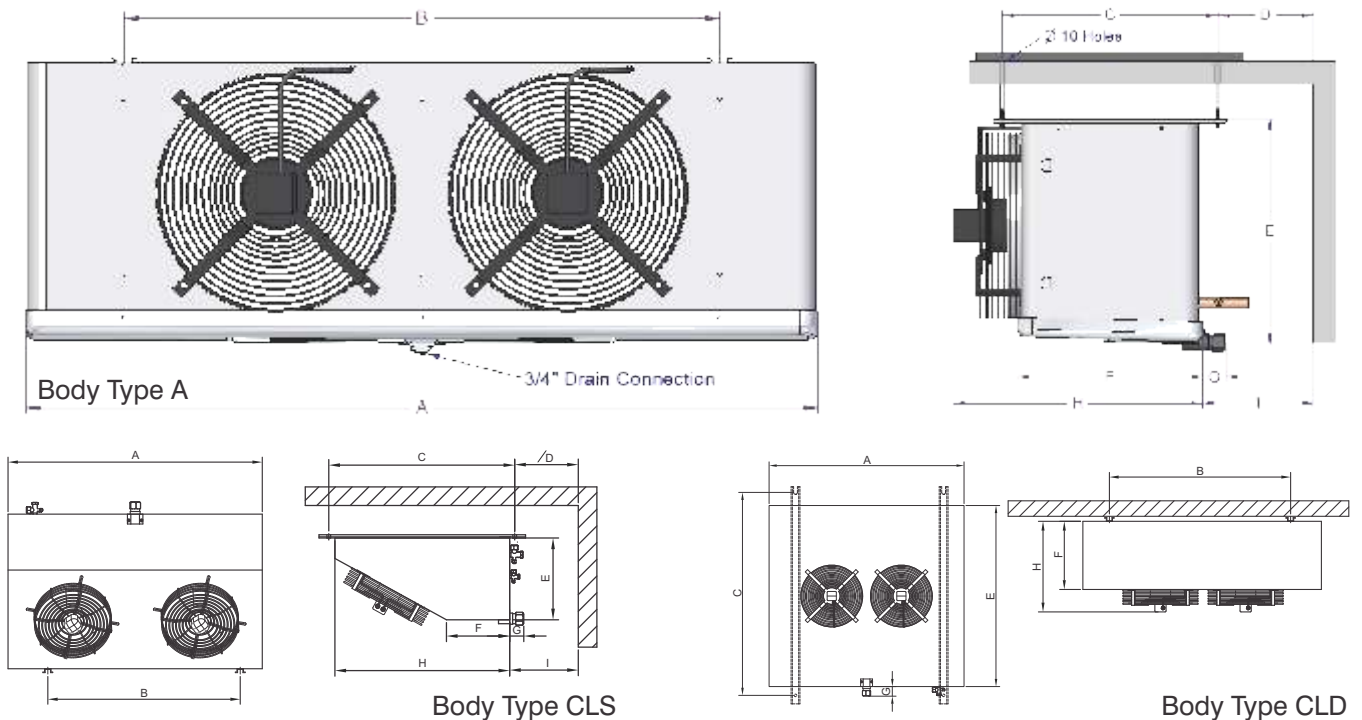

Physical Parameters	Dimensions (mm) for Model									
	A4007-301H	A4012-302H	A4018-303H	A4024-353H	A4034-353H	A4039-452H	A4058-453H	CLS709-252A	CLD713-252A	CLD724-253A
	A7012-301A	A7021-302A	A7032-303A	A7043-353A	A7060-353A	A7062-452A	A7090-453A			
A	765	1095	1490	1575	1880	1880	2660	825	820	1150
B	485	815	1210	1300	1605	1595	2380	685	680	1010
B1	NA	NA	NA	430	535	800	800	NA	NA	NA
C	375	375	375	375	375	375	375	530	750	750
D	350	350	350	350	350	400	400	300	NA	NA
E	410	410	410	480	550	635	635	220	720	720
F	325	325	325	325	325	325	325	190	220	220
G	40	40	40	40	40	40	40	40	40	40
H	435	435	435	435	435	460	460	500	315	315
I	375	375	375	375	375	425	425	375	0	0
Unit Weight (kg)	17	26	35	46	57	75	115	15	24	36

## Features

- 1) High efficiency heat exchanger with in-line tube system for minimum loss of air flow between fins and with large surface area for long cooling time.
- 2) Fan Motor and Heater wires are connected in terminal box mounted inside the unit.
- 3) Fan motors are of leading brand. Insulation Class F, thermally protected against overload and can be used on 230V/50 Hz supplies.
- 4) Provision given for installing tray heater later.
- 5) Stainless steel mounting rail.
- 6) Compact, adjustable & easily openable side panels for easy installation.
- 7) Heater rods are arranged for better heat distribution in coil. Electric heater rods are inserted into special aluminium sleeve tubes to avoid steam formation.
- 8) Drainage Connection

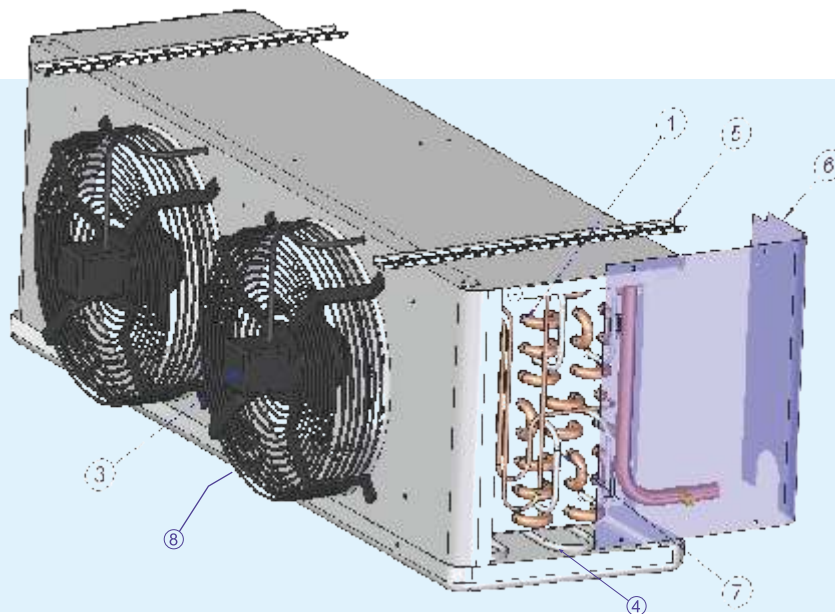

### Unit Body:

- 1.2mm thick Aluminium, PU type white powder coated, corrosion resistant and nice appearing body.
- Round corner Drain tray and also provided intermediate sheet to avoid condensation.
- Aluminium Die cast, threaded, 3/4" diameter drainage connection.

### Finned coil block:

- Aluminium fin, thickness 0.30 mm
- Shedder Valve provided for gas charging.
- Coils are degreased, cleaned and tested with 25 bar air pressure and leak test under water according to standard.

### Fan Motor:

- Axial fans with external rotor motor, single phase - 230V, 50/60 Hz with internally wired thermal contact and wired with internal terminal box.
- Electrical design according to standard.
- Protection class: IP-54, Insulation Class F
- Application range : -35°C to +40°C

### Defrost Heating:

- Electric heater rods 230V sleeve tube with 7-8 mm diameter

## Technical Specifications

EVAPORATOR UNIT (Evap. Temp. -8°C to -35°C)								
Sr.	Parameters/Model	A4007-301H	A4012-302H	A4018-303H	A4024-353H	A4034-353H	A4039-452H	A4058-453H
1	Capacity (kW) (at -25°C, DT1=7K)	1.25	2.5	3.8	5.0	6.8	8.27	11.7
2	Heat Transfer Area (m <sup>2</sup> )	6.9	12.15	18.23	24.3	34	39.12	58.12
3	Tube Volume (In Ltr)	2.5	3.4	5	7	10.21	10.5	15.5
4	Fin Spacing-mm/FPI(Fin Per Inch)	6/4	6/4	6/4	6/4	6/4	6/4	6/4
5	Fan Diameter / No. of Fans / ph	300/1/1ph	300/2/1ph	300/3/1ph	350/3/1ph	350/3/1ph	450/2/3ph	450/3/3ph
6	Air Flow (m <sup>3</sup> /h) / Throw(Mtr)	1560/9	3120/9	4680/10	8200/12	8200/12	8600/14	12900/14
7	Motor - Input Value (watts)	87 x 1	87 x 2	87 x 3	150 x 3	150 x 3	320 x 2	320 x 3
8	Motor - Current (Amp.)	0.42 x 1	0.42 x 2	0.42 x 3	0.65 x 3	0.65 x 3	0.74 x 2	0.74 x 3
9	Coil & Tray Heater Total (watts)	2750	4000	4600	5500	5500	6550	9450
10	Pipe Inlet & Outlet	1/2 & 7/8	1/2 & 7/8	1/2 & 7/8	5/8 & 1.1/8	5/8 & 1.1/8	5/8 & 1.1/8	5/8 & 1.3/8

EVAPORATOR UNIT (Evap. Temp. 10°C to -8°C)								
Sr. NO	Parameters/Model	A7012-301A	A7021-302A	A7032-303A	A7043-353A	A7060-353A	A7062-452A	A7090-453A
1	Capacity (kW) (at -8°C, DT1= 8 K)	1.75	3.5	5.25	7	9.5	13.5	19
2	Heat Transfer Area (m <sup>2</sup> )	12.3	21.3	32.1	42.6	59.5	62.45	90.75
3	Tube Volume (In Ltr)	2.5	3.4	5	7	10.21	10.5	15.5
4	Fin Spacing-mm/FPI(Fin Per Inch)	3.6/7	3.6/7	3.6/7	3.6/7	3.6/7	3.6 / 7	3.6 / 7
5	Fan Diameter / No. of Fans / ph	300/1/1ph	300/2/1ph	300/3/1ph	350/3/1ph	350/3/1ph	450/2/3ph	450/3/3ph
6	Air Flow (m <sup>3</sup> /h) / Throw(Mtr)	1560/9	3120/9	4680/10	8200/12	8200/12	8600/14	12900/14
7	Motor - Input Value (watts)	87 x 1	87 x 2	87 x 3	150 x 3	150 x 3	320 x 2	320 x 3
8	Motor - Current (Amp.)	0.42 x 1	0.42 x 2	0.42 x 3	0.65 x 3	0.65 x 3	0.74 x 2	0.74 x 3
9	Pipe Inlet & Outlet	1/2 & 7/8	1/2 & 7/8	1/2 & 7/8	5/8 & 1.7/8	5/8 & 1.1/8	5/8 & 1.1/8	5/8 & 1.3/8

EVAPORATOR UNIT (Evap. Temp. 10°C to -4°C)						
Sr. NO	Parameters/Model	CLS709-252A	CLD713-252A	CLD719-252A	CLD724-253A	CLD729-253A
1	Capacity (kW) (at -2°C, DT1= 8 K)	1.45	2.35	3.2	5.2	6.1
2	Heat Transfer Area (m <sup>2</sup> )	9.76	13.02	19.52	24.4	29.3
3	Tube Volume (In Ltr)	1.92	2.56	3.84	4.7	5.64
4	Fin Spacing-mm/FPI(Fin Per Inch)	3.6/7	3.6/7	3.6/7	3.6/7	3.6/7
5	Fan Diameter / No. of Fans	250/2	250/2	250/2	250/3	250/3
6	Air Flow (m <sup>3</sup> /h) / Throw(Mtr)	2000/4	2000/4	2000/4	3000/4	3000/4
7	Motor - Input Value (watts)	50 x 2	50 x 2	50 x 2	50 x 3	50 x 3
8	Motor - Current (Amp.)	0.25 x 2	0.25 x 2	0.25 x 2	0.25 x 3	0.25 x 3
9	Pipe Inlet & Outlet	3/8 & 1/2	3/8 & 1/2	3/8 & 5/8	3/8 & 3/4	3/8 & 3/4

**Air flow (m<sup>3</sup>/h) :-** The air flow is determined on a suction side chamber testing stand according to ISO 5801 with dry cooler surface.

**Air throw(m) :-** The air throw gives the distance from the outlet area of the air cooler at which the average of the air velocity taken at 0.5 m, 0.75 m and 1 m from the ceiling at 20°C equals 0.5 m/s.

**Capacity (kW) :-** The capacity data are based upon measurement according to standard at the following conditions :

- Refrigerant R404A,
- Liquid temperature 30°C resp. 20°C ( for evaporating temperatures below -20°C)
- The superheat of refrigerant between outlet and inlet is considered 65%

The selection diagram and the capacity table are already considering the influence of the air humidity and specify the actual capacity of the cooler under operating conditions (wet or frosty cooler surface).

We, **Bharat Refrigerations**, provide most advanced fruits ripening rooms for fruits like mango, banana and papaya. We provide forced draft cooling system for uniform ripening of fruits even in large capacity rooms. We use blended gas system for the purpose of ripening which is acceptable as per universal standard. With our system, client has unique advantage of controlling ripening cycle from four to fifteen days! We provide precise gas monitoring system for better storage life of the produce.





## The essential requirements of an ethylene ripening system are:

- A reasonably air tight room with insulation
- A temperature control system for cooling and/or heating
- An air circulation and ventilation system
- Humidity control
- An ethylene gas injection system
- An electric control system

## We Offer Ripening Chamber

Manual (Time Based), Semi Automatic & Automatic

We ensure that each ripening chamber is designed to maintain the precise conditions required for specific application. Features of our ripening chamber such as,

- Microprocessor controlled and compatible with computer
- Low Cost and light weight, constructed with PUF-panels
- Low investment and maintenance cost
- Easy to commission, Swing or Sliding door
- Ripening capacities from 5 tons to 25 tons for each chamber
- Moveable from one site to another and expandable
- Controlled levels of Ethylene, CO<sup>2</sup>, Temperature, Humidity & Time
- Energy efficient, uniform and quality ripening
- Ripening chambers are reliable with energy-efficient refrigeration units

## Gas Emission Systems Features

- Safe
- Flexible system
- Intelligent control
- Independent settings
- Programmable

### Daily Ripening Chart

8 Days	14.5°	14.5°	14.5°	14.5°	14.5°	14.5°	14.5°	14.5°
7 Days	15.5°	15.5°	15.5°	15.5°	14.5°	14.5°	14.5°	14.5°
6 Days	16.5°	16.5°	15.5°	15.5°	14.5°	14.5°	14.5°	
5 Days	16.5°	16.5°	16.5°	16.5°	15.5°	14.5°		
4 Days	18.0°	18.0°	16.5°	15.5°	14.5°			
	Days 1	Days 2	Days 3	Days 4	Days 5	Days 6	Days 7	Days 8

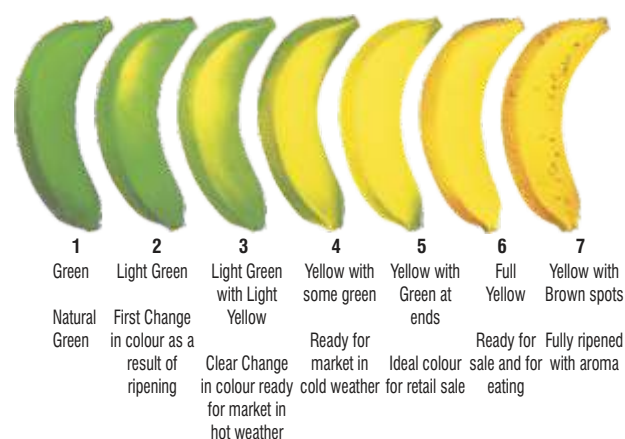

## Ethylene Exposure:

Sr.No.	Product Details	Ethylene Concentration (PPM)	Ethylene Exposure Time (Hours)	Ripening Temperature (°C)	Storage Temperature after Ripening(°C)
1	Banana	100-150	24-48	15-18	13-14
2	Mango	100	24	20-22	10-13
3	Papaya	100	24-48	20-25	About at 7

## Industrial Refrigeration

- Water Chilling Plant
- Brine Chilling Plant
- Oil Chilling Plant
- Air Chilling Plant
- Ice Building Tank (IBT)

## Ammonia Refrigeration

- Turnkey Projects for Cold Stores
- Water Chillers for Dairy
- Glycol Chillers for milk deep chilling for dairy
- Glycol chillers for beverage plants
- Glycol chillers for brewery plants
- Water Chillers for Pharma
- LP Receivers with Ammonia Pumps for retrofit plants
- Ice Accumulating Coils
- Atmospheric Condensers

## Commercial Refrigeration

- Ice Cream Mix Plant
- Batch Pasteurizer
- Ageing Vat
- Bulk Milk Chiller
- Ice Candy Production Machine
- Ice Cream Hardener (Static/Tunnel Type)
- Mini Blast Freezer & Chiller
- Heat Pump Food Dehydrator

## Transport Refrigeration

- Refrigerated Vehicle (GRP)
- Refrigerated Van - Eutectic (GRP)
- Detachable Mobile Container (GRP)
- Bunk House
- Dry Insulated Container (GRP)

## OUR VALUED CLIENTS



- Head Office & Manufacturing Plant-I
- Manufacturing Plant-II
- Branch Offices, Dealers & Associates and Company Representatives

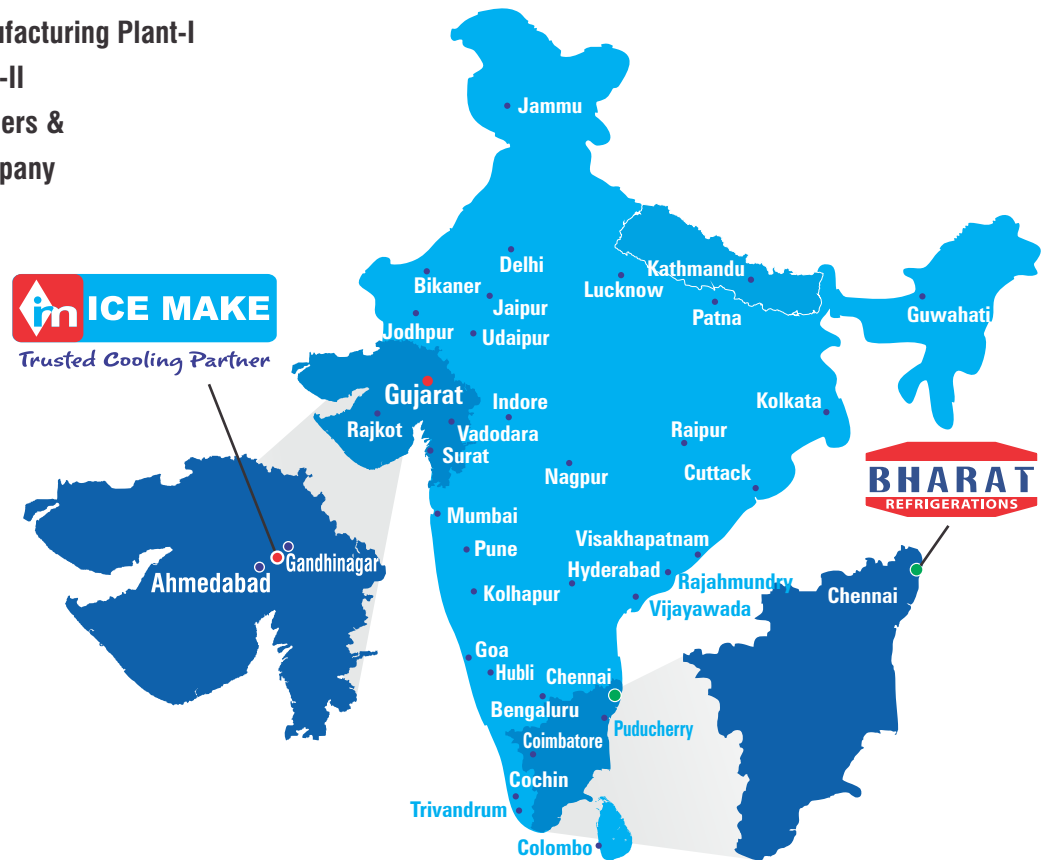

## PROJECT DETAILS

### Vadera Trade Link Pvt. Ltd.

Product : Multi Commodity  
 Product Range : Multi Storey Cold Storage  
 Storage Capacity Approx. : 4000 Metric Ton  
 Location : Barmer, Rajasthan

### Sri Balasanka Mills

Product : Tamarind & Dhal  
 Product Range : Cold Storage  
 Storage Capacity Approx. : 300 Metric Ton  
 Location : Theni, Tamil Nadu

### Ariba Food Products Pvt. Ltd.

Product : Ready to Eat Frozen Food  
 Product Range : Blast Chiller, Blast Freezer & Cold Storage.  
 Storage Capacity Approx. : 185 Metric Ton  
 Location : Indore

### Kitchen Express Ltd.

Product : Spices & Grocery  
 Product Range : Cold Storage  
 Storage Capacity Approx. : 2500 Metric Ton  
 Location : Ahmedabad

### Himalayan Food Park

Product : Tomato  
 Product Range : Cold Storage  
 Storage Capacity Approx. : 1250 Metric Ton  
 Location : Uttarakhand

### Hansaraj Exports

Application : Fruits Storage  
 Product Range : Cold Storage  
 Storage Capacity Approx. : 1500 Metric Ton  
 Location : Jammu

### RPM Engineers (India) Ltd (Nandini Milk)

Product : Milk and Buttermilk  
 Product Range : Cold Storage  
 Storage Capacity Approx. : 60,000 Litres  
 Location : Koppal, Karnataka

### M.A. Banana Supplier

Product : Banana  
 Product Range : Banana Ripening - Multi Chamber  
 Storage Capacity Approx. : 88 Metric Ton  
 Location : Baroda

### India Dairy Product Ltd.

Product : Ice Cream & Milk  
 Product Range : Cold Storage  
 Storage Capacity Approx. : 56,000 CFT  
 Location : Kolkata

### N.B. Ice Cream

Product : Ice Cream  
 Product Range : Cold Storage  
 Storage Capacity Approx. : 3.75 Lakhs Litres  
 Location : Ranchi



## Bharat Refrigerations Pvt. Ltd.

(Wholly Owned Subsidiary of ICE MAKE REFRIGERATION LIMITED)

Manufacturer of Industrial Refrigeration Equipment & Reefers

B-20, 1st Main Road, Ambattur Industrial Estate, Chennai - 600058.

E-mail: [info@bharatref.in](mailto:info@bharatref.in) | Web: [www.bharatref.in](http://www.bharatref.in)

Sales: +91 9791175004 | Service: 1800 102 4615



*Trusted Cooling Partner*

### ICE MAKE REFRIGERATION LIMITED

Commercial & Industrial Refrigeration Equipment Manufacturer & Exporter

226, Dantali Industrial Estate, Gota-Vadsar Road, Nr. Ahmedabad City,

At-Dantali, Ta: Kalol, Dist.: Gandhinagar - 382721, Gujarat, India.

E-mail: [enquiry@icemakeindia.com](mailto:enquiry@icemakeindia.com) | Web: [www.icemakeindia.com](http://www.icemakeindia.com)